

INDIVIDUAL MASCULINO

1	Pablo Pérez Navarro (UGR)		
2	BYE 1		
3	Pablo Baena Marín (CEU)	2 6 - 6	
4	Edoardo Ciato (IE)	0 2 - 0	
5	Carlos Calero López (UV)	0 2 - 0	
6	Gerard Oltra Giral (UB)	2 6 - 6	
7	BYE 6		
8	Pablo García Aguado (UAX)		
9	Iago Domínguez Álvarez (CUNEF)		
10	BYE 3		
11	Mateo Montoya Martínez (ULOYOLA)	2 6 - 6	
12	Sergio Muñoz Sánchez (UMH)	0 4 - 0	
13	Marcos Palazón Lacasa (USJ)	1 6 - 2 - 1	
14	Markel Garay Eceolaza (MUNI)	2 2 - 6 - 10	
15	BYE 5		
16	Samuel García Hernández (ULL)		
17	Mario Mansilla Díez (UI1)		
18	BYE 7		
19	Jorge López Domínguez (UPM)	2 6 - 6	
20	Juan Lacal Pelegrín (UM)	0 0 - 0	
21	Oliver Bandera Elena (UMA)	2 6 - 6	
22	Victor Ruiz Blázquez (UCA)	0 1 - 0	
23	BYE 4		
24	Fernando Ferrandis Gargallo (UCV)		
25	Pablo De la Cierva Sánchez (UCAM)	0 4 - 1	
26	Álvaro D. García Ramírez (UAO)	2 6 - 6	
27	Pablo Roy Donaire (UFV)	2 6 - 6	
28	Carlos Encinas Galán (UEX)	0 2 - 0	
29	Pablo Jiménez Martínez (UJI)	2 7 - 6	
30	Íñigo Zúñiga Gaztambide (UNAV)	0 6 - 1	
31			
32	Alejandro López Escribano (USE)		

1/4 DE FINAL

SEMIFINAL

FINAL

3° / 4°

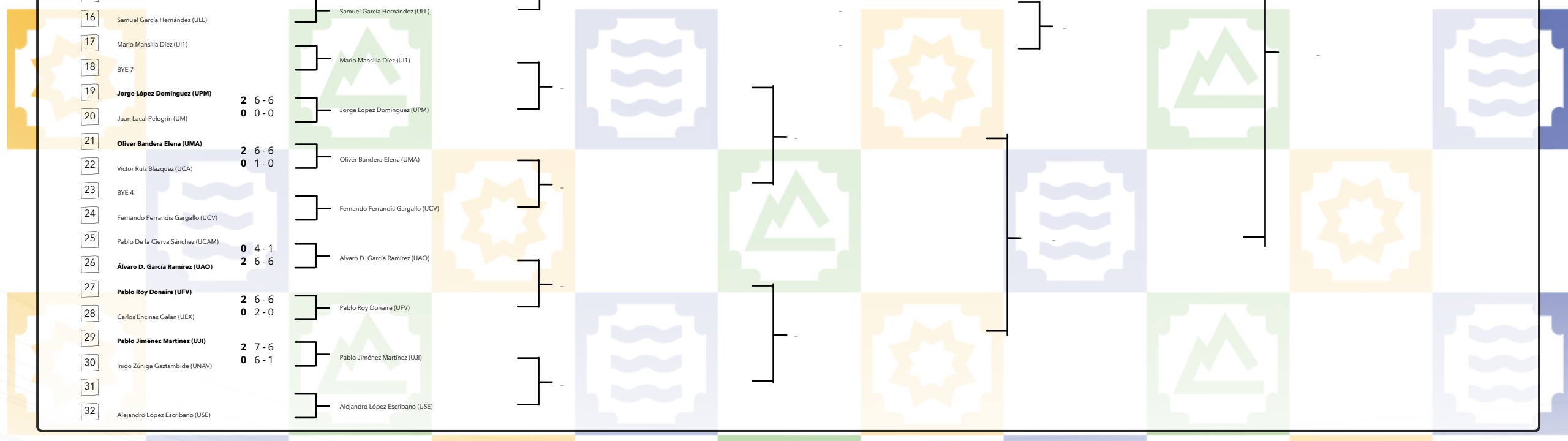

INDIVIDUAL FEMENINO

1	Alba Rey García (UCAM)	
2	BYE 1	
3	Laia González Angelet (UAC)	
4	BYE 9	
5	Sara Minguez Rodríguez (UPV)	
6	BYE 13	
7	BYE 8	
8	Maritzel Boix Molla (UV)	
9	Celia Campo Muñoz (CEU)	
10	BYE 4	
11	Nerea Eguiguren Oyarzabal (UPV)	
12	Victoria Fijo Castillo (USE)	
13	Lucía Frnández Fernández (UMA)	
14	BYE 10	
15	BYE 7	
16	Encarnación García Ávila (UGR)	
17	Valeria Martínez Bonet (UMH)	
18	BYE 5	
19	Nerea Sevilla Gómez (UCLM)	
20	BYE 11	
21	Ariane Monlleó Sanchiz (IE)	
22	BYE 14	
23	BYE 3	
24	Carlota Mulet Bouza (URJC)	
25	Lucía Ibarrola Asenjo (UNAVARRA)	
26	BYE 6	
27	Alexandra M. Pascota (UAH)	
28	BYE 12	
29	Maria Bakulina Fandiyenko (DEUSTO)	
30	Ana Romero González (UAB)	
31	BYE 2	
32	Andrea Palazón Lacasa (USJ)	

2 5 - 6 - 10
1 7 - 4 - 8

0 4 - 1
2 6 - 6

1/4 DE FINAL

SEMIFINAL

FINAL

3° / 4°

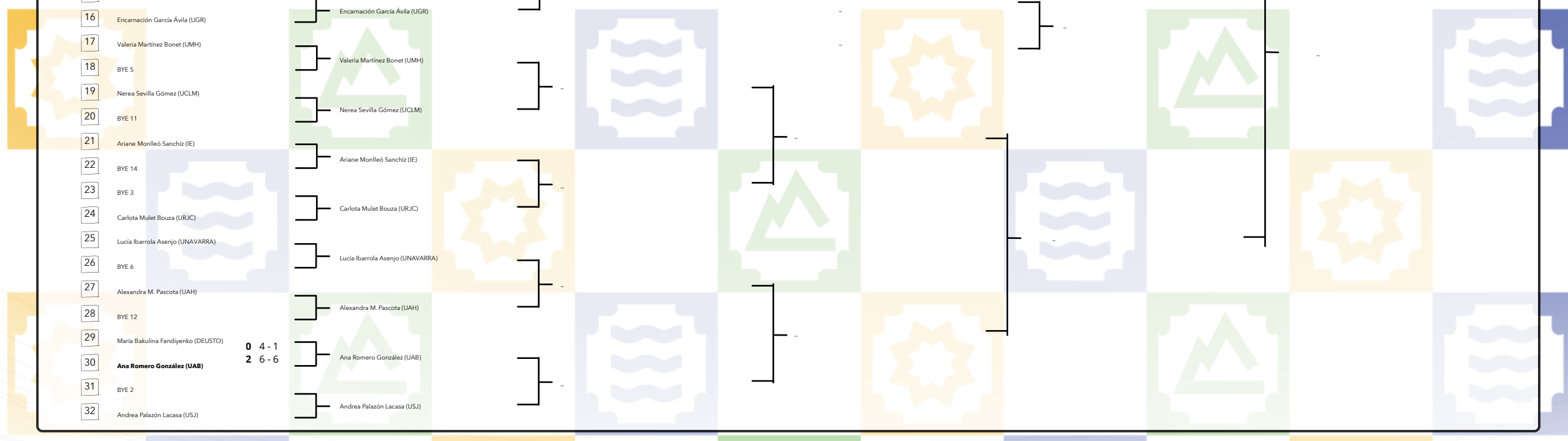

DOBLES MASCULINO

1/4 DE FINAL

SEMIFINAL

FINAL

- 1 Jaime Caldés - Jesús García (UCAM)
- 2 BYE
- 3 Tao Auriol - Alberto Butunoiu (UDG)
- 4 Benjamín Alain - Marco La Cagnina
- 5 Ricard Soriano - Xavier Vila (UV)
- 6 Pietro Ciceri - Aryan J. Vurghese (IE)
- 7 Guillermo Carrasco - Miguel Rueda (UCA)
- 8 Adrián Castrillo - Alonso Rodríguez (USE)
- 9 Jesús Cano - Sergio González (UM)
- 10 Pablo Lafuente - Unai Laguardia (UPV)
- 11 Víctor Moreno - Jorge Pérez (UMH)
- 12 José Miguel Fernández - Alejandro Muñoz (UGR)
- 13 Daniel Aldea - Ignacio Mostoles (UPM)
- 14 Antonio Cuadrado - Sergio Vargas (UMA)
- 15 BYE
- 16 Ignacio Ayuso - Tristán Caballero (CEU)

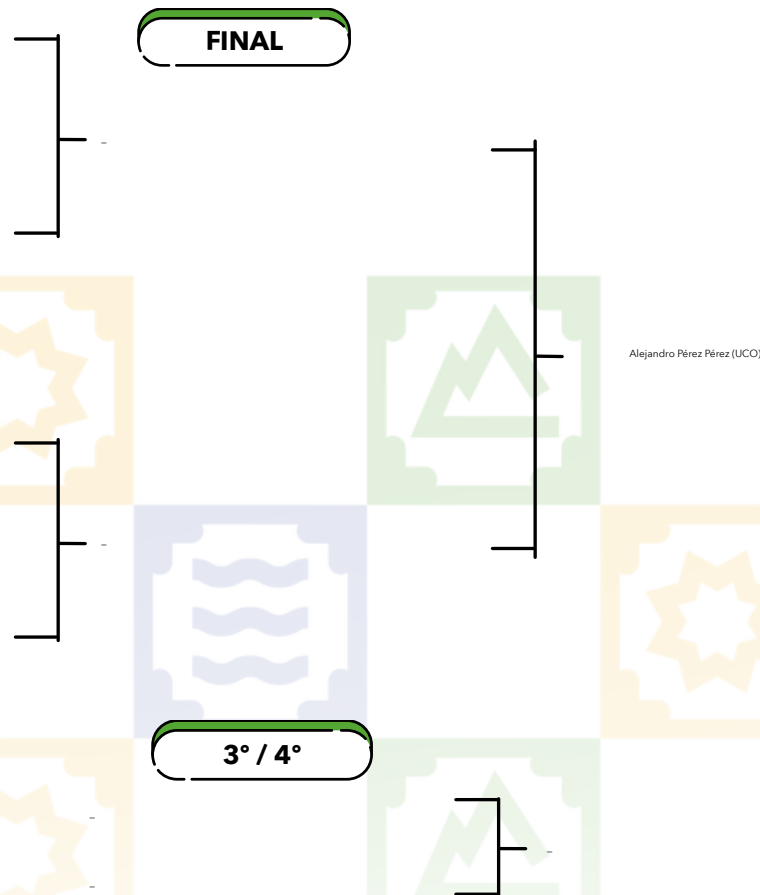
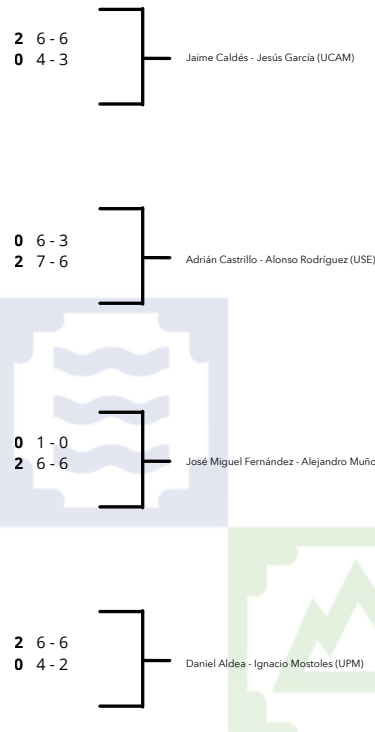
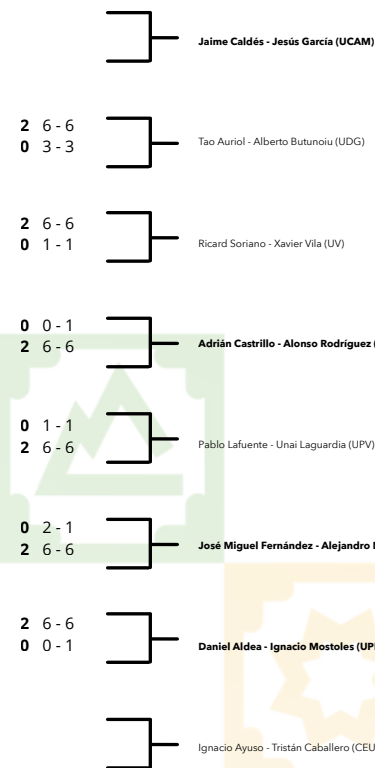

DOBLES FEMENINO

1/4 DE FINAL

SEMIFINAL

FINAL

- 1 Lucía Fernández - María Villar (UGR)
- 2 BYE
- 3 **Carmen Juan - María Pastor (UMH)**
- 4 Eva Rodríguez - L. Andrea (UPM)
- 5 Lorena Martín - Paula Martín (UAH)
- 6 BYE
- 7 Olivia Anderson - Sofía N. Andrei (UMA)
- 8 **M. Carmen Jurado - Leyre Morales (USE)**
- 9 Julia Audisio - Carlota Noguera (UM)
- 10 BYE
- 11 BYE
- 12 Eva García - Laura Martínez (UCAM)
- 13 Ariadna Ondo - Cristina Schaale (UPV)
- 14 **Elif Tuna - Mariia Pyrozhenko**
- 15 BYE
- 16 Blanca Martí - María Martín (UV)

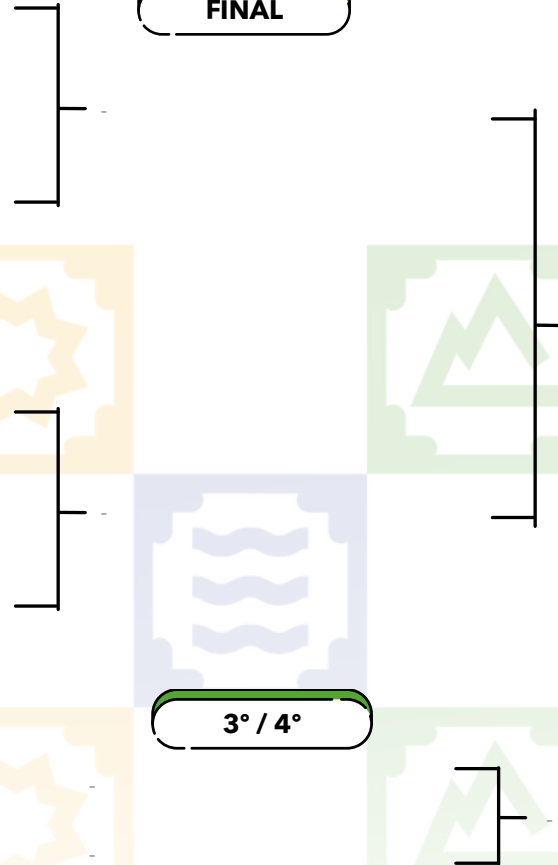
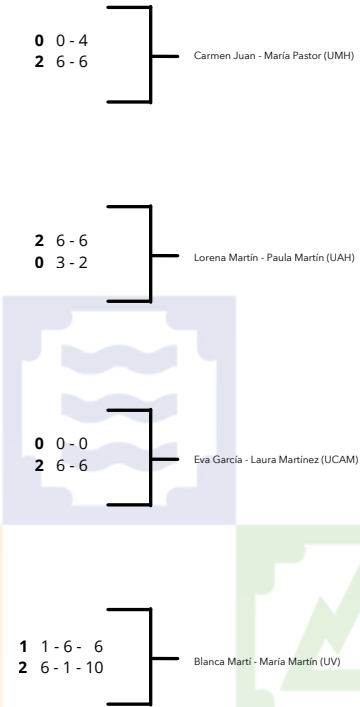
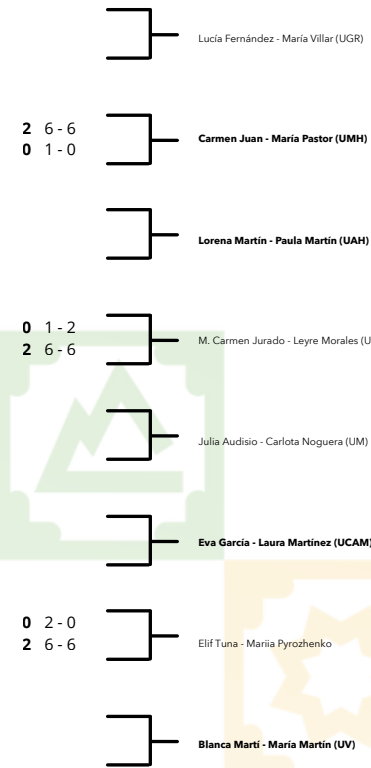

3° / 4°

DOBLES MIXTOS

1/4 DE FINAL

SEMIFINAL

FINAL

- 1 Eva Rodríguez - Daniel Aldea (UPM)
- 2 BYE
- 3 Carlota Noguera - Manuel Sánchez (UM)
- 4 Laura Martínez - Jesús García (UCAM)
- 5 Lucía Martínez - Kike Llopis (UV)
- 6 BYE
- 7 M. Carmen Jurado - Adrián Castrillo (USE)
- 8 BYE
- 9 Carmen Juan - Victor Moreno (UMH)
- 10 Ariadna Ondo - Benjamin Jeanne-Grandinot (UPV)
- 11 BYE
- 12 Lucía Fernández - José Miguel Fernández (UGR)
- 13 Laia Pelegrín - Alberto Butunoiu (UDG)
- 14 Martina Ferreres - Pablo Archilés (UJI) **WO**
- 15 BYE
- 16 Sofía N. Andrei - Sergio Vargas (UMA)

Eva Rodríguez - Daniel Aldea (UPM)

-

Lucía Martínez - Kike Llopis (UV)

M. Carmen Jurado - Adrián Castrillo (USE)

-

Lucía Fernández - José Miguel Fernández (UGR)

Laia Pelegrín - Alberto Butunoiu (UDG)

Sofía N. Andrei - Sergio Vargas (UMA)

-

-

-

-

-

-

3° / 4°

-

-